



Made in France



Ref: CH 80 M

DIMENSIONS

Seat height : 31.5inch
Seat height w/ backrest: 44.1inch
On the ground: 16.5 x 16.5inch
Seat diameter: 13.2inch

WEIGHT

14.3lbs

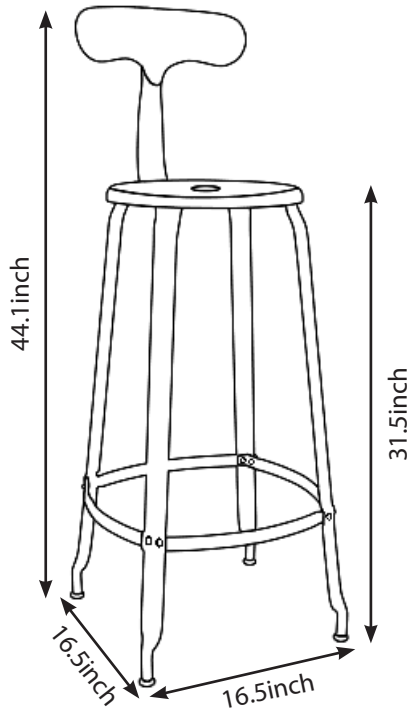

CHAISES NICOLLE®

CHAIR 32inch Metal

TECHNICAL SHEET



TECHNICAL SPECIFICATIONS

MANUFACTURER	SARL CHAISES NICOLLE
COUNTRY OF ORIGIN	France
DESCRIPTION	Metal chair with removable backrest
STRUCTURE	Stamped metal
CHAIR FEET	Polyethylene
POWDER COATING	AXALTA® POLYESTER AE GLOSS Approvals: P-0634
STANDARD FINISHES	<ul style="list-style-type: none"> - RAL 1007 - Glossy Daffodil Yellow - RAL 3020 - Glossy Traffic Red - RAL 2004 - Glossy Pure Orange - RAL 5024 - Glossy Pastel Blue - RAL 6003 - Matte Olive Green - RAL 9005 - Matte Black - RAL 9016 - Glossy White - Matte January 1 (Matte Dark Steel) - February 4 (Steel Grey) - RAL 5017 - Textured Traffic Blue - RAL 9010 - Textured Pure White
CARE AND CLEANING	<p>«Indoor» or sheltered «outdoor» use. Dust with a dry or slightly wet cloth. Do not use abrasive cleaners or harsh chemicals. Do not expose to excessive humidity.</p>