



Made in France



Ref: CH 45 B

DIMENSIONS

Seat height : 47cm

Seat height with backrest: 80cm

On the ground: 36 x 36cm

Seat diameter: 33,5cm

WEIGHT

5,1 kg

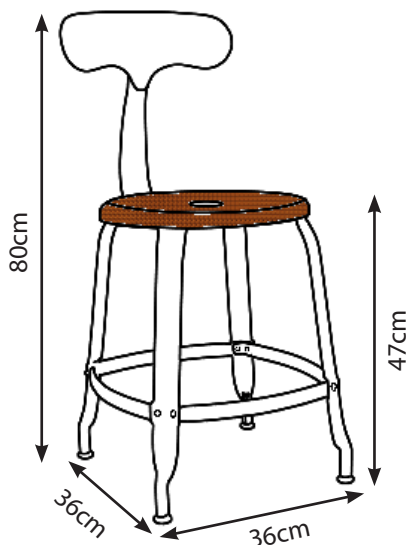

CHAISES NICOLLE®

CHAIR H45 Wood

TECHNICAL SHEET



TECHNICAL SPECIFICATIONS

MANUFACTURER	SARL CHAISES NICOLLE
COUNTRY OF ORIGIN	France
DESCRIPTION	Metal chair with removable backrest and wooden seat
STRUCTURE	Stamped metal
WOODEN SEAT	Varnished beech. In accordance with PEFC ST 2002:2013 and 2001:2008 requirements
CHAIR FEET	Polyethylene
POWDER COATING	AXALTA® POLYESTER AE GLOSS Approvals: P-0634
STANDARD FINISHES	<ul style="list-style-type: none">- RAL 1007 - Glossy Daffodil Yellow- RAL 3020 - Glossy Traffic Red- RAL 2004 - Glossy Pure Orange- RAL 5024 - Glossy Pastel Blue- RAL 6003 - Matte Olive Green- RAL 9005 - Matte Black- RAL 9016 - Glossy White- Matte January 1 (Matte Dark Steel)- February 4 (Steel Grey)- RAL 5017 - Textured Traffic Blue- RAL 9010 - Textured Pure White

CARE AND CLEANING

«Indoor» use only.

Dust with a dry or slightly wet cloth.

Do not use abrasive cleaners or harsh chemicals.

Do not expose to excessive humidity.